

Rieter - Card C 60

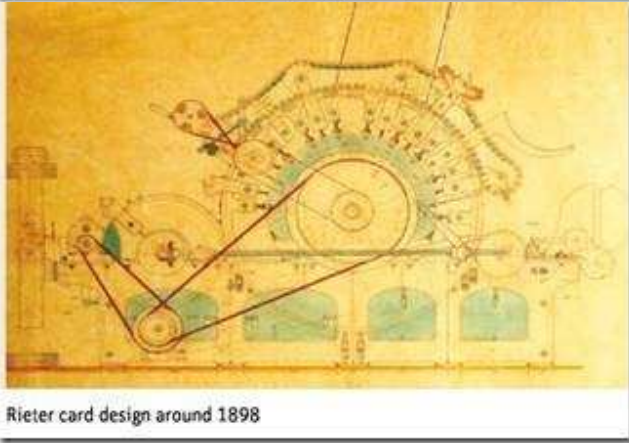

Rieter card design around 1898

Over 17 000 cards of the C series have been produced since 1981 and have been delivered to our customers world-wide. Rieter strives constantly to increase the productivity without any curtailment in the quality: this has always been the great challenge in development.

Rieter has equipped the C 60 card with a whole series of outstanding characteristics to accomplish this challenging task:

- Advanced card concept with the unconventional working width of 1.5 m and new geometry
- High production performance of up to 220 kg card sliver per hour
- Compact design with a small machine footprint which allows the highest comparative productivity per unit area
- Innovative card chute feeding system with built-in fine opening roller
- Single and triple licker-in for optimal adaption to all spinning systems
- Automatic card clothing sharpening using the integrated grinding system IGS for long clothing service life and constant sliver quality
- Modular construction to minimize the machine downtimes
- Shortening the production process by the integration of the SB drawframe module without autolevelling or, alternatively, the RSB drawframe module with autolevelling

THE C 60 COMBINES TRADITION WITH INNOVATION

The unsurpassed productivity of the C 60 card is the product of experience, innovation and a cost-conscious development process. This productivity is decisive for the high economics of the C 60 because the production costs are directly impacted and reduced by:

- Low space requirements and thus lower building overhead costs
- Lower expenditure for the filter installation
- Reduced maintenance expenditure primarily as a result of the modular design and through longer clothing service lifetimes resulting from automatic card wire sharpening with IGS (Integrated Grinding System)
- Lower specific energy consumption (kWh/kg yarn)
- Superb running performance, low downtimes, and thus a high production efficiency

NEW GEOMETRY FOR PRODUCTIVITY AND QUALITY

Increased productivity and the same high sliver quality are our constant challenges. The solution is to be found in the C 60 card with its revolutionary concepts.

The C 60 features a completely new geometric design. The most important features are:

- Increased working width from 1 000 mm to 1 500 mm for a 50% wider carding area
- Smaller cylinder diameter

These two factors enable a productivity increase without curtailing the quality of the sliver and the final product. The smaller cylinder diameter permits a higher cylinder speed and a higher carding precision.

A significantly improved trash elimination is offered thanks to the greater centrifugal forces. This is most important above all in the rotor spinning process. The wider carding area and the higher precision leads to a generally better result in carding.

MODULAR CONCEPT

The modular concept consists of:

- Licker-in module
- Flat module
- Doffer module

These modules reduce the maintenance and personnel expenses as well as the machine downtimes. The easy exchange of modules permits a problem-free adjustment of the card to to very different requirements of the final products.

CONSTANT HIGH QUALITY

The IGS (Integrated Grinding System) for wire maintenance ensures a constant high sliver quality, increases the wire service life and reduces the downtime for maintenance to a level never achieved before.

C 60 – PRODUCTIVITY FOR ALL APPLICATIONS

The new concept permits an increase in the production quantities in all applications. The C 60 requires the same or less space than conventional cards thanks to its brilliantly thought- and compact construction.

THE CONCEPTUAL FEATURES OF THE C 60 AT A GLANCE:

- Wider working width
- Greater carding angle
- Smaller cylinder diameter
- Modular concept
- Integrated Grinding System – IGS

ADVANTAGES OF THE C 60:

- Highest productivity
- Constant high sliver quality
- Efficient trash elimination
- Lowest energy consumption per kilogram card sliver

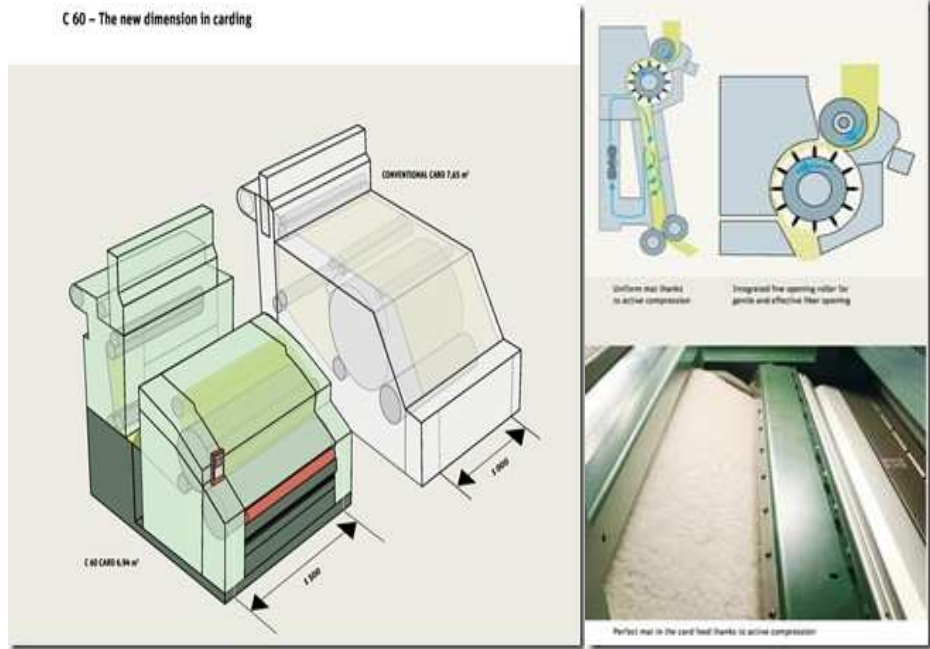

The innovative card feeding system

OPTIMAL MATERIAL PREPARATION

The integrated card chute feed of the C 60 was developed for a perfect preparation of the raw material, i.e., small fiber tufts and a uniform mat.

GENTLE BUT EFFECTIVE MATERIAL OPENING

The integrated fine opening roller in the chute with feed trough and adjustable roller speed provides for a gentle but effective fiber opening. The transferring of the opening step from the cleaning machines to the card has clear advantages:

- Low nep increase as the result of lower fiber transport
- Gentle opening as a result of the lower production rate and the distribution over a larger working width

Well-opened tufts are fundamental for an effective carding, for nep and trash reduction and for an increased lifetime of the card clothing.

ACTIVE COMPRESSION

An integrated fan provides active compression of the fiber material, which is the basis for an even and uniform mat structure. This again is essential for:

- Constant high sliver quality
- Low count deviations
- Low Cv values
- High production efficiency

ECONOMICS

The fine mat structure reduces operating costs for two reasons: It increases the service life of the card clothing by up to 50% and thus reduces maintenance; this has a positive effect on the cost of maintenance and on the downtime.

ADVANTAGES OF THE C 60 CARD CHUTE FEED SYSTEM

- Fewer neps as a result of the gentle fiber separation in the filler

- Longer service life of the licker-in wires
- Shorter machine downtimes
- The best Cv values thanks to the homogenous mat

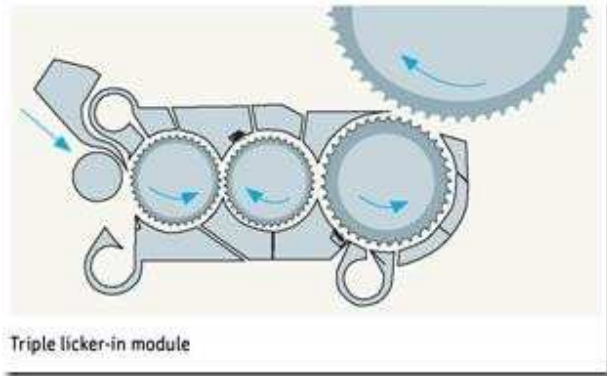

BEST CONDITIONS FOR ALL APPLICATIONS

Depending on the end product – synthetic yarn, fine cotton yarn, rotor yarn or yarn made from regenerated fiber – the process requirements are very different. At the same time, the feasible card production varies between 45 and 220 kg/h. In one case a gentle fiber opening and nep reduction are called for in first line, in another case high productivity and the elimination of trash are particularly important. Here the mote knives at the licker-in can be adjusted during production. As a result, optimum raw material exploitation and a flexible adaptation to various raw materials are emphasized. The C 60 offers an optimal configuration, no matter what the mill requirements are.

HIGH RAW MATERIAL EXPLOITATION

In carded and combed ring yarn applications, as well as for regenerated fibers, it is important to make full use of the supplied fiber properties. Extensive research with the single licker-in show not only a gentle fiber opening, together with a reduced elimination of good fiber, but also a highly economical process. In this way the fiber properties such as length and strength are preserved and thus contribute to high yarn quality.

HIGH PRODUCTIVITY FOR ROTOR YARN APPLICATION

The tendency to even higher rotor speeds continues; consequently there is a move to even smaller rotor diameters. The minimizing of trash particles in the sliver is important for the successful operation of such small rotors. In this case the use of a triple licker-in module can be the appropriate solution for maximized trash elimination with the gentlest treatment. Carding segments and mote knives at all rollers extract trash particles efficiently. As a result production rates of up to 220 kg/hour are achieved for rotor yarn applications.

FLEXIBLE SYSTEM

The licker-in module can be changed within minutes without difficulty. The exchange of an entire licker-in module in the card reduces the downtime and the work is significantly simplified.

Efficient nep and trash removal

PRE- AND POST-CARDING AREA

Carding elements separate trash, dust and short fibers in the pre- and post-carding areas. Guiding elements and the associated mote knives are responsible for the extraction of the impurities. Different sets of carding elements are available to meet the requirements for a specific yarn type.

MAIN CARDING AREA

After the pre-carding area, the fibers enter the active carding area. Mill trials have shown that stronger centrifugal forces support the separation and elimination of trash, short fibers and seed-coat fragments.

AUTOMATIC WIRE SHARPENING

The inevitable wear of the card clothing becomes an even more crucial issue with any high production card. The Integrated Grinding System (IGS) – a unique Rieter feature – solves this fact fundamentally by keeping the wires sharp at all times.

The advantages are:

- Constant sliver quality over the entire service life of the wires
- Better carding, i.e. better nep and trash elimination as a result of the constantly sharp wires
- No downtime whilst the cylinder and flat clothing is ground because this is an automated and computer-controlled system
- Major simplification of maintenance work
- Increased service life of the cylinder wires and thus very economical
- Ideally suited for the newest generations of cylinder wires where manual grinding is problematic

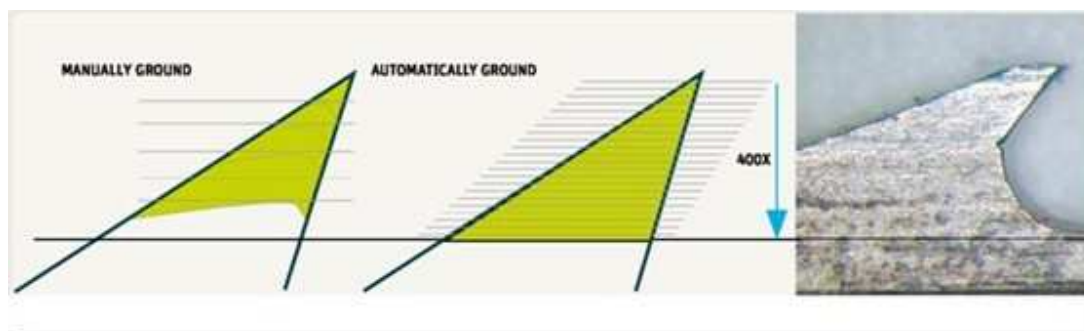

THE FLAT MODULE

The unique flat module consists of 79 precision flats and guarantees extensive removal of neps and trash. The modular concept permits the complete exchange of the flat module in a short time. If necessary, individual flats can be changed in the machine.

ADVANTAGES:

- Effective removal of impurities
- Efficient nep removal

- Minimal machine downtime thanks to the rapidly exchanged flat module
- Constant high sliver quality using IGS

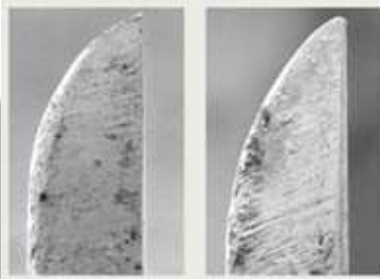

Wires after 240 tons production, with IGS Top on the left-hand side, on the right – without



IGS - Top



IGS - Classic

Short amortization time

SEPARATE LICKER-IN WASTE DISPOSAL

The separate licker-in waste disposal is an option which is amortized very quickly for the C 60. The more valuable flat waste can be separated from the trash-containing licker-in waste using the separate waste disposal, and can then either be sold off as valuable raw material or be used in the spinning mill for producing rotor yarn. Characteristics of the discontinuous waste disposal are:

- A very economical discontinuous waste disposal analogous to blow room machines
- A visual assessment of the waste composition is possible at any time
- A waste box on rollers offers efficient handling during maintenance and servicing work

TAILORED TO REQUIREMENTS

The separate waste disposal at the licker-in can operate with a continuous or discontinuous suction depending on the option selected. In the continuous waste disposal process, the waste from the licker-in is carried continuously to a separate filter in the spinning mill. The optimal system can be selected from the two options for waste disposal from the spinning mill



Waste disposal box for discontinuous suction of waste from the licker-in



C 60 unit with separate suction of the licker-in waste

Fine yarns with excellent running properties

Q-PACKAGE – THE SPECIAL PRE- AND POST-CARDING AREA The Q-Package in the pre- and post-carding area consists of a total of 9, in place of 6, carding elements and 5, in place of 4, mote knives. These are integrated in high precision and dimensionally stable profiles. In this manner an improved nep removal and a very selective elimination of trash particles is achieved in addition to an especially gentle treatment of the fiber. These advantages are particularly important in the production of ring-spun yarn.

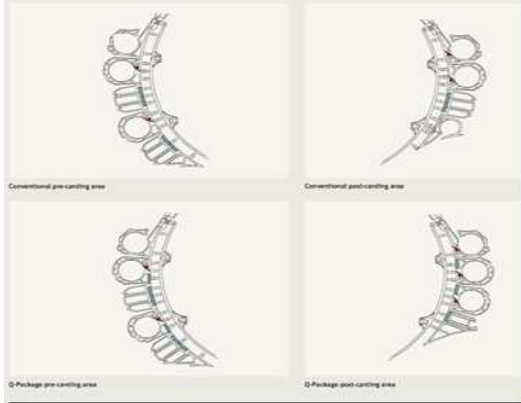

FROM WEB TO SLIVER

Perfect fiber control

SLIVER FORMATION

The formation of the sliver is carried out over a dynamically controlled transport of the fleece, two cross aprons and a pair of disk rollers. Hence, it is possible to produce fine 4 ktex slivers safely at a production rate of up to 275 m/min.

EASY HANDLING

In the event of a sliver break the operator simply activates a lever and guides the new sliver into the can coiler or into the drawframe module.

MID-TERM LEVELLING

The feeding trough measures the mat thickness of the chute feed. According to the determined values, the feed roller speed of the card is automatically adapted to maintain a consistent sliver count.

LONG TERM LEVELLING

The sliver count is measured by a disk roller pair. The measured signals are processed and transmitted to control the chute feed system.



Simple operation



Well-arranged panel

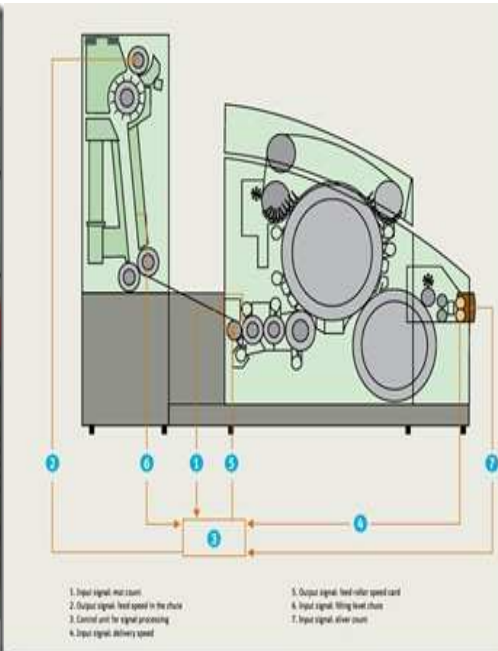

The drawframe module of the C 60

BASED ON EXISTING KNOW-HOW

The C 60 drawframe module is based on:

- 25 years of unsurpassed Rieter specialized expertise with automatic levelling systems
- 25 000 high performance drawframes sold

PROCESS INTEGRATION

The integration of a drawframe not only improves the economics but also the productivity. In particular instances the yarn quality can even be improved by the use of the direct process in rotor spinning. The drawframe module is available in two versions: The C 60 SB without autoleveller system and the C 60 RSB with the well-proven Rieter autoleveller system.

Depending on the yarn count, the raw material and the spinning technology, the number of conventional drawframe passages can be reduced from two to one (C 60 SB) or from one to zero (direct process with C 60 RSB).

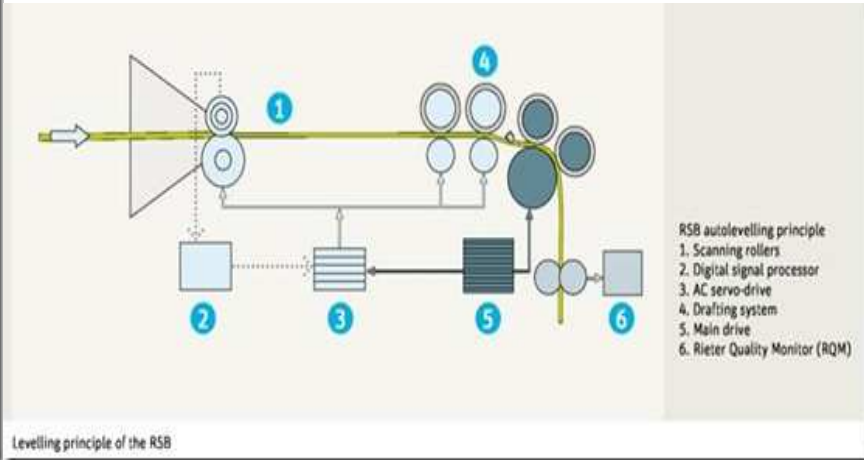

ADVANTAGES WITH THE DRAWFRAME MODULE

- Shorter and faster production process
- 100% levelled sliver with the C 60 RSB
- Increased productivity with low space requirements
- Fewer cans needed
- Reduced labor expenditure
- No accidental can mixing

TECHNOLOGY

The C 60 RSB is equipped with a digital fast-acting levelling system. The evenness of the C 60 card sliver is checked using the proven „tongue and groove“ scanning disks. The pneumatic loading of the rollers guarantees constant scanning. The values measured are used by the digital signal processor to determine a nominal value for the high-dynamic servodrive. This value is transmitted at exactly the instant when the measured card sliver segment enters the levelling point within the main drafting zone.

MAXIMUM LEVELLING

The Rieter autoleveller system ensures top sliver quality for the downstream processes. The decisive difference is achieved by levelling 100% of the sliver as well as in the production or doffing mode.



Minimal machine downtime

C 60 – REVOLUTIONARY DESIGN

In addition to the modern and attractive appearance of the C 60, comprehensive ergonomic improvements have been integrated. These guarantee the operator-friendliness and minimized machine downtime.

IGS SYSTEM

Today the major cause of machine downtimes in carding is the sharpening of the card wires. Loss of production caused by the requirement for grinding has been eliminated by the introduction of the IGS system. The IGS system improves sliver quality and extends the life of cylinder and flat clothing.

EASY EXCHANGE OF MODULES

The exchange of the licker-in, flat and doffer clothing is a time-consuming maintenance operation in conventional carding. The modular construction of the C 60 reduces these downtimes to levels never achieved before. All three modules can be exchanged more easily with prepared optional spare modules. Each of these operations only requires a single service person. Thus, for example, the licker-in module can be entirely exchanged in less than 90 minutes.

With the IGS system and the modular machine concept, Rieter has taken a major step in reducing machine downtime with a constant and better sliver quality at the same time.

ADVANTAGES OF THE MODULAR CONSTRUCTION

- User-friendly concept
- Minimum machine downtimes
- Reduced maintenance load

· Constant high sliver quality

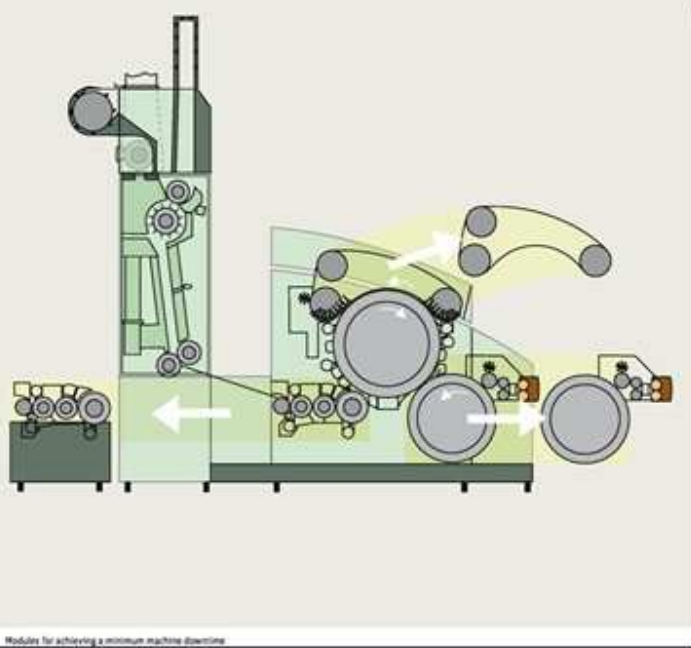

ECONOMIC PRODUCTION The C 60 card sets new standards in productivity and quality. Economy completes these two strengths to form a harmonic whole. These important features are supported by an entire bouquet of measures.

HIGHER PRODUCTION WITH SMALLER SPACE REQUIREMENTS The dimensions of a spinning mill depend on various factors. Depending on the yarn count, they are determined by the number of spinning machines or by the preparatory stages before spinning. The high productivity of the C 60 permits a very economical building layout. (Example given below: yarn Ne 6.5, 100% cotton, raw material consumption = 1 227 kg/hour, yarn production = 1 125 kg/hour)

The direct rotor spinning process with integrated drawframe is the most efficient yarn production system. Capital and production costs are reduced to a minimum.

MINIMUM MACHINE DOWNTIME The machine concept with the licker-in, flat and doffer module makes maintenance easy and reduces the machine downtime. The IGS system again reduces downtime and maintenance cost to a never experienced minimum.

TOP PERFORMANCE BASED ON FACTS Economic considerations are based on figures and facts. Equipment, personnel, energy and servicing costs play an important role in achieving an outstanding economic performance. Test our expertise on your specific project and ask for figures and facts, i.e. production costs per kg yarn. The personnel requirements calculated for the mill example below are 0.45 operator hours per 100 kg yarn (HOK), - an extremely low value.

ADVANTAGES

- High production per square meter
- Process integration with SB or RSB module possible
- Fewer cans required
- Fewer personnel required
- Lower energy consumption
- Simpler maintenance
- Ease of operation

